

CM350704
EZP544MBE

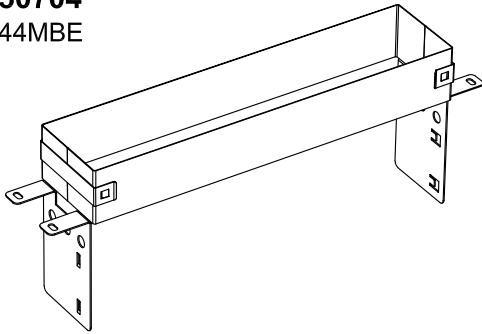

Please refer to CM350704 Application Sheet and Installation Sheet

CM250058
EZD44T
2 to 5x

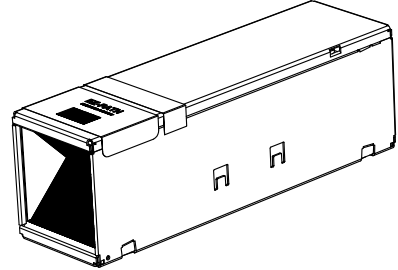

To be ordered separately

CM350704 + CM250058
EZP544MBE + EZD44T

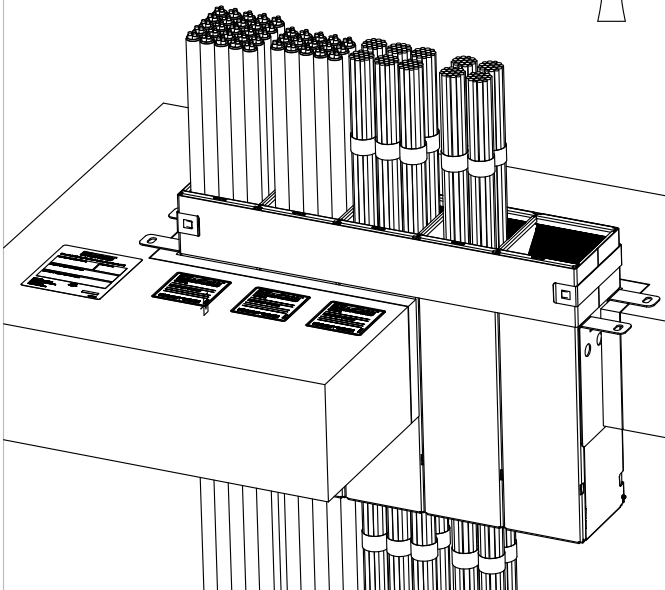
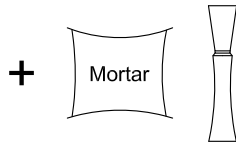

Ordering information



CM350704



0.80



1

Applications

For all types of cables up to Ø21mm OD
Rigid floors

Performance

Fire resistance : EN1366-3
Classification : EN13501-2

Firestop handling

No handling required for the fire safety compliance

Dimensions

Bracket width : 57 mm

Opening dimensions

542 x 144 mm
(+/- 8mm)

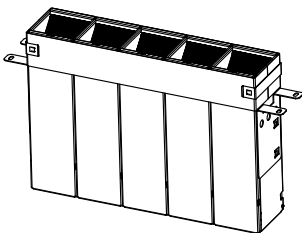

440 x 144 mm
(+/- 8mm)

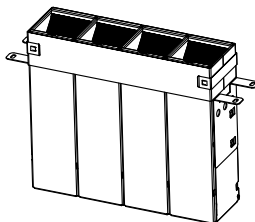

330 x 144 mm
(+/- 8mm)

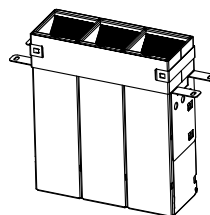

216 x 144 mm
(+/- 8mm)

